

行星革新起重
科技改变行业



FIXED SEATED ELECTRIC HOIST 固定坐式电动葫芦

河南三智装备科技有限公司
Henan Sanzhi Equipment Technology Co., Ltd

SZW

CATALOGUE 目录

01\

Company Profile

公司简介

02\

Technical Parameter

技术参数

03\

Product Advantages

产品优势

04\

Service

服务

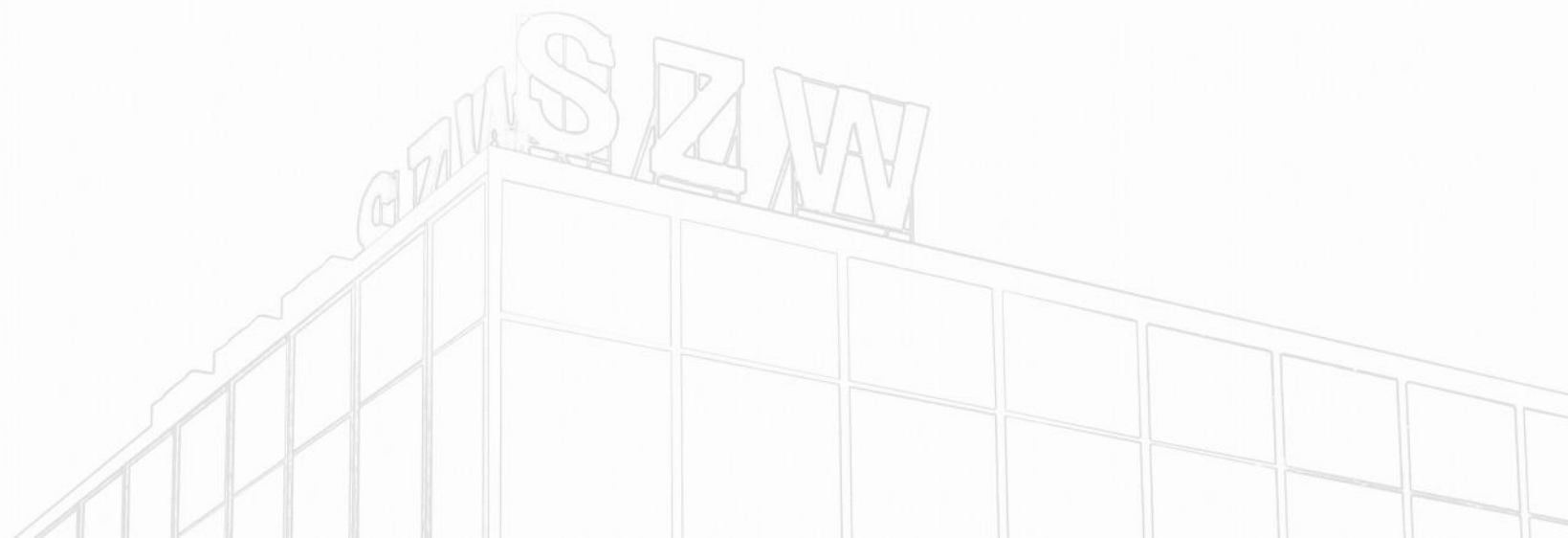

COMPANY PROFILE

企业简介

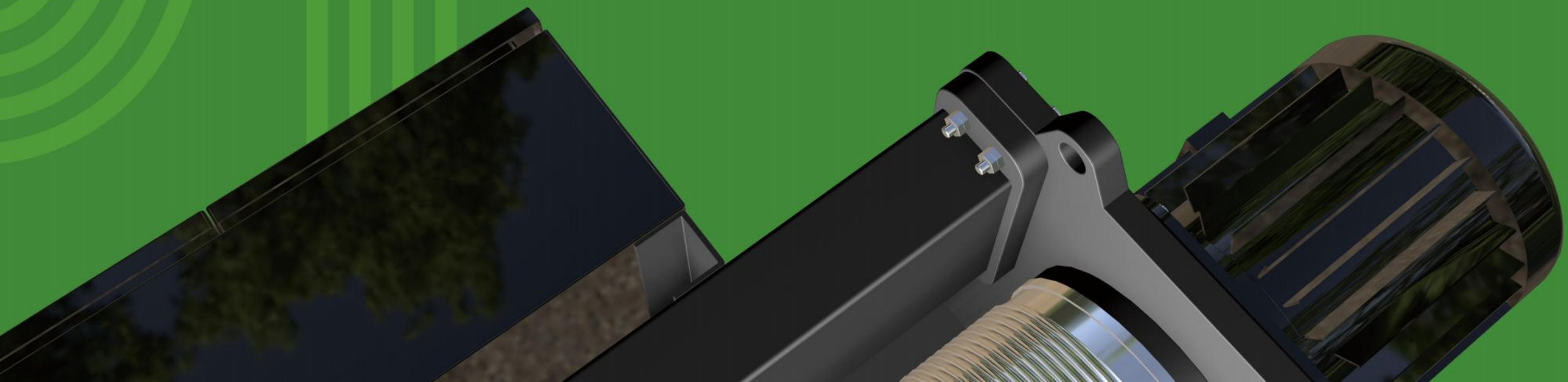

COMPANY PROFILE

企业简介

河南三智装备科技有限公司，坐落于河南（长垣）起重工业园区，是一家专注于起重装备相关配套零部件高端制造的企业，尤其以行星减速机作为核心传动部件，在行业内独树一帜。凭借精湛的制造工艺与卓越的产品品质，公司在高端起重装备精密制造领域声名远扬，与中联重科、中信重工、宝武钢铁、酒钢集团、鸿路钢构、广东富华、山东龙马、河南东起、宁波力劲、明阳智能等众多国内行业头部企业建立了全面且深入的战略合作关系。

在创新发展的道路上，三智装备积极与高校开展产学研合作，与太原科技大学、河南工业大学、西安电子科技大学等多所知名高校携手，构建深度校企合作模式。在大力销售推广三代起重装备产品核心部件的同时，公司与太原科技大学在海安研究院展开紧密协作，针对行星减速机、高端集成电器等关键产品进行深度研发与应用探索。这一系列举措不仅为当下产品的升级优化提供了有力支撑，更为新型第五代高端起重装备的技术革新提前布局，做好充分的技术储备。

三智装备始终将科技创新、深化服务以及提供优质产品作为企业发展的核心宗旨。秉持着这一理念，公司矢志不渝地为用户呈上卓越的产品与专业的服务，致力于为起重机高端配套零部件领域开辟更为先进的供应链体系与市场模式，全方位推动高端起重装备产业的变革与发展，引领行业迈向新的高度。

公司高度重视质量管理与企业规范化运营，顺利通过了 ISO90001、ISO45001、ISO14001 等国际认证，并分别荣获“质量管理体系认证证书”“职业健康安全管理体系认证证书”“环境管理体系认证证书”。这一系列认证标志着公司在质量管理、职业健康安全以及环境保护等方面达到了国际先进水平，具备了坚实的管理基础与规范的运营流程。

公司产品种类丰富多样，涵盖新型行星电动葫芦、新型行星电动双梁小车、新型低净空电动葫芦、端梁系列产品、AGV、RGV、KBK、行星车轮组（车轮、行星减速机、联轴器、电机、制动器）、行星起升机构、行星旋转吊钩、行星旋转吊具、行星变幅机构等众多产品类型。在生产过程中，公司对传动机构、结构、部件的制作严格遵循欧洲工艺标准，每一个环节都精益求精。凭借这种对品质的执着追求，公司产品的性能超越了国内外同类产品的技术水平，能够精准满足不同客户的多样化需求。三智装备始终秉持着“上下求索细研品质”的精神，将卓越品质作为给予客户的坚实保障。其产品凭借优异的性能与可靠的质量，广泛应用于冶金、矿山、起重运输、电力、化工、造船、港口、电子、军工、食品等多个行业领域，赢得了市场的高度认可与赞誉。

以匠心精雕细琢，用品质赢得信赖，
我们不做市场的过客，只做行业的标杆。



用科技突破品质边界，以创新定义行业标准，
我们不止于合格，更追求极致。

服务不是流程，而是一场双向奔赴，
您的满意，是我们最大的成就。



SZW

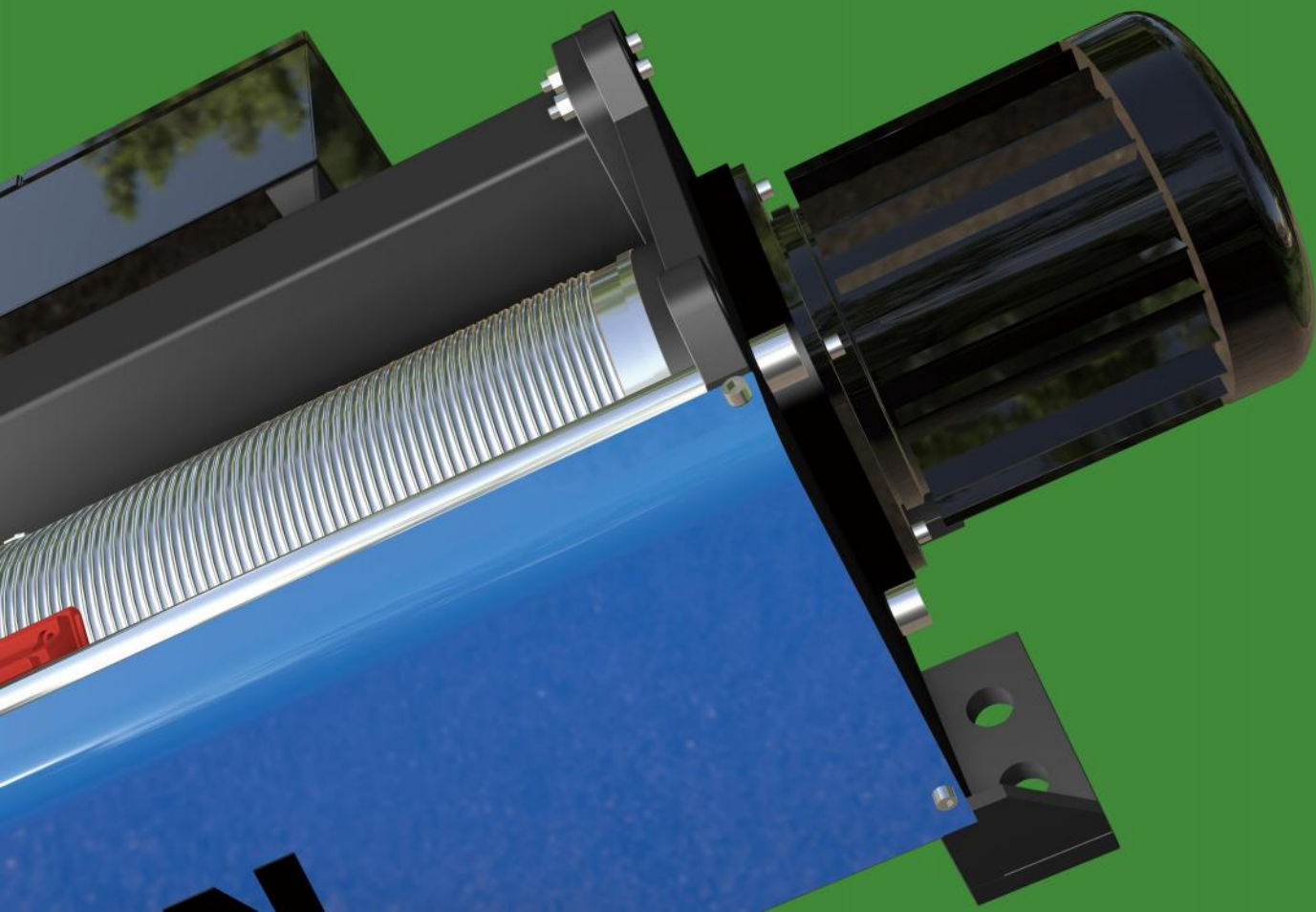

WIN THE FUTURE WITH INNOVATION
用新赢未来



技术参数
**TECHNICAL
PARAMETER**

PARAMETER 技术参数

A FIXED SEATED ELECTRIC HOIST 固定坐式电动葫芦

根据力学结构设计，反复实验，修改细节。使其结构更紧凑，受力更合理，节省原材料，有效的实现起升高度的增加，更坚固、更安全。模块化设计、效率高、免维护智能环保、坚固耐用、安全设计。

Design according to mechanical structure, conduct repeated experiments, and modify details. Make its structure more compact, stress more reasonable, save raw materials, effectively increase lifting height, and be more sturdy and safe. Modular design, high efficiency, maintenance free intelligent environmental protection, sturdy and durable, safe design.

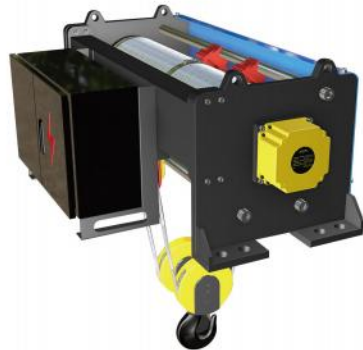

固定坐式电动葫芦

Fixed seated electric hoist

起重量(t)	3.2/5/10/16/20/32/50	Lifting capacity (t)	3.2/5/10/16/20/32/50
起升高度(m)	6/9/12/15/18	Lifting heights(m)	6/9/12/15/18
起升速度 (m/min)	0.3-3/0.36-3.6/0.4-4/0.5-5 0.55-5.5/0.6-6/0.7-7/0.8-8	Lifting speed (m/min)	0.3-3/0.36-3.6/0.4-4/0.5-5 0.55-5.5/0.6-6/0.7-7/0.8-8
工作级别	2m(M5)/3m(M6)	Classification group	2m(M5)/3m(M6)

PARAMETER
技术参数

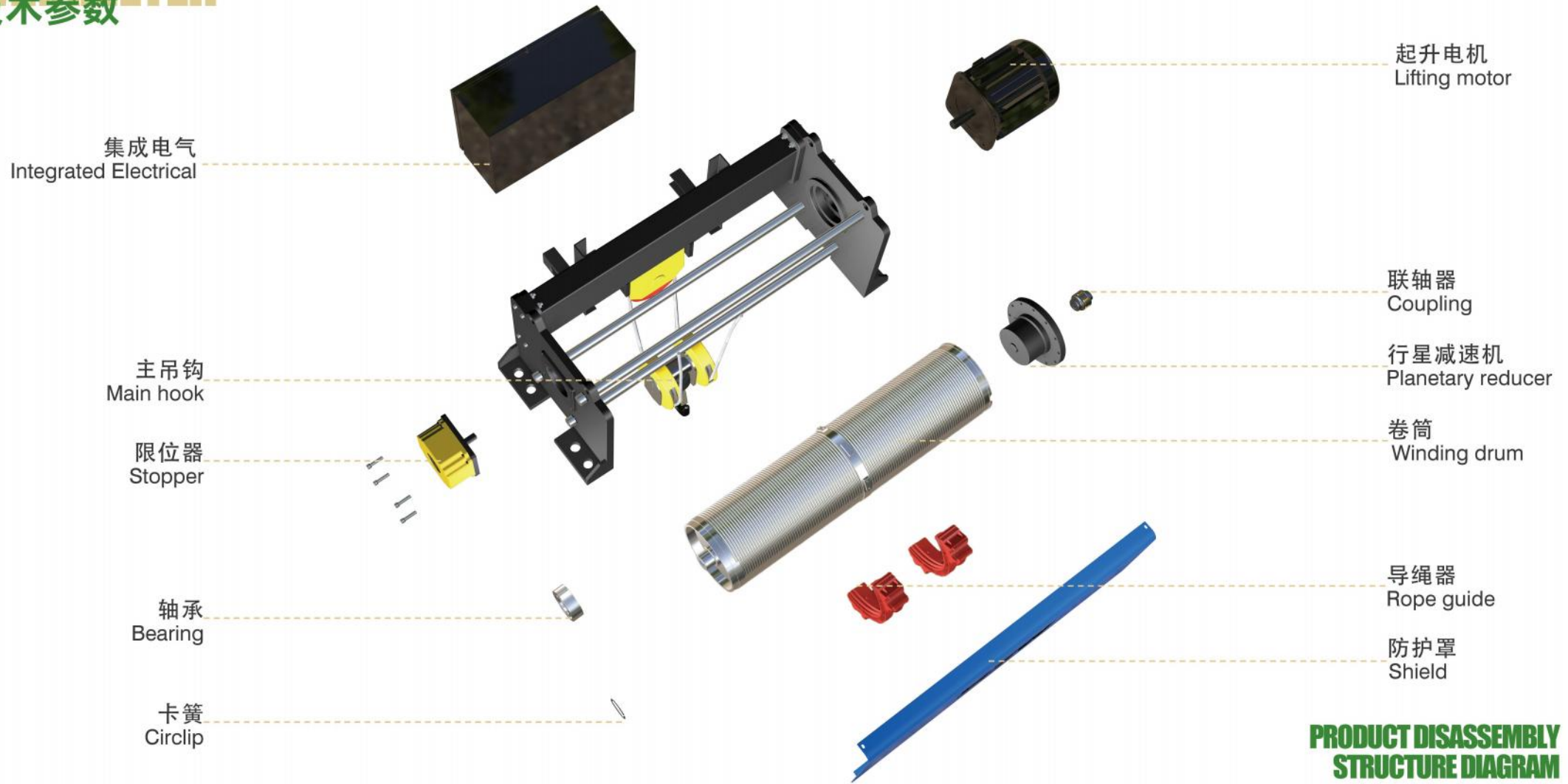

PARAMETER 技术参数

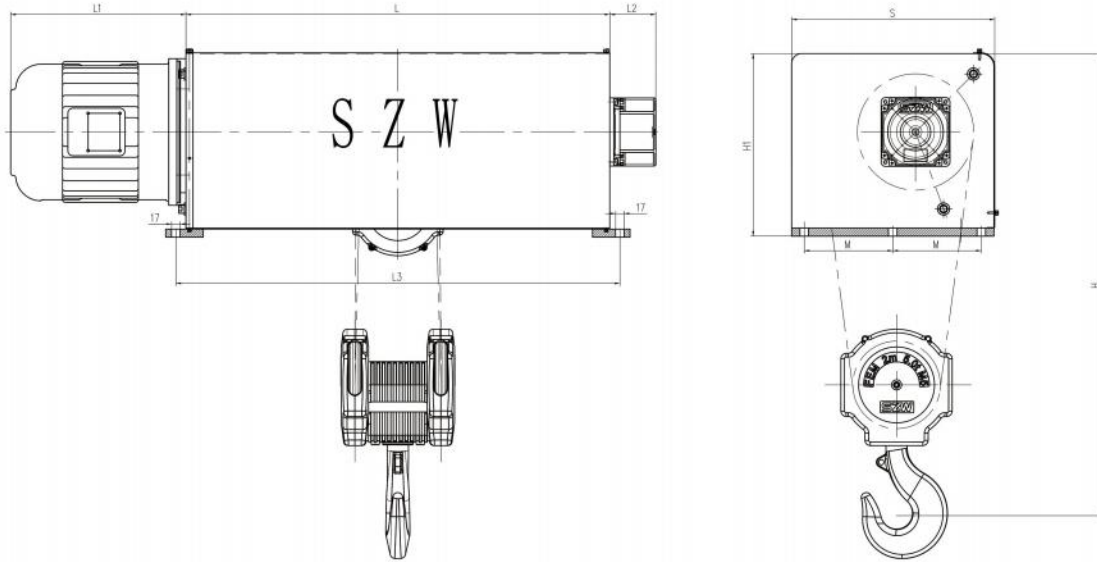

SWL(kg)	Work group FEM/ISO	Hoisting 起升速度可双速或变频		5t
		Speed (m/min)	Motor (KW)	
2500	2m/M5	5	5.5	
2500	2m/M5	8	7.5	

HOL(m)	L(mm)	L1(mm)	H(mm)	S(mm)	M(mm)	H1(mm)	Weight (kg)
9	840	410/440	845	440	220	345	325
12	1040	410/440	845	440	220	345	375
15	1240	410/440	845	440	220	345	450
18	1440	410/440	845	440	220	345	550

SWL(kg)	Work group FEM/ISO	Hoisting 起升速度可双速或变频		10t
		Speed (m/min)	Motor (KW)	
5000	2m/M5	5	9	
5000	2m/M5	7	13	

HOL(m)	L(mm)	L1(mm)	H(mm)	S(mm)	M(mm)	H1(mm)	Weight (kg)
9	1108	460/500	845	440	220	345	750
12	1308	460/500	845	440	220	345	800
15	1508	460/500	845	440	220	345	850
18	1708	460/500	845	440	220	345	1050

SWL(kg)	Work group FEM/ISO	Hoisting 起升速度可双速或变频		16t
		Speed (m/min)	Motor (KW)	
3200	2m/M5	3.5	13	
3200	2m/M5	8	15	

HOL(m)	L(mm)	L1(mm)	H(mm)	S(mm)	M(mm)	H1(mm)	Weight (kg)
9	1276	500/530	895	540	270	395	850
12	1476	500/530	895	540	270	395	900
15	1726	500/530	895	540	270	395	950
18	1926	500/530	895	540	270	395	1000

SWL(kg)	Work group FEM/ISO	Hoisting 起升速度可双速或变频		3.2t
		Speed (m/min)	Motor (KW)	
1600	2m/M5	5	3	
1600	2m/M5	8	4.5	

HOL(m)	L(mm)	L1(mm)	H(mm)	S(mm)	M(mm)	H1(mm)	Weight (kg)
9	790	370/390	845	440	220	345	275
12	990	370/390	845	440	220	345	325
15	1140	370/390	845	440	220	345	400
18	1340	370/390	845	440	220	345	500

SZW

CREATING QUALITY WITH CARE
用心造品质

PRODUCT ADVANTAGES

产品优势



ADVANTAGES

产品优势

1 ROPE GUIDE

导绳器

使用粘塑性极强的高韧性合成材料制成，其具有耐磨性好，使用周期长，即使在恶劣情况下也有极高的安全性。自动调节松紧，自动压紧钢丝绳，避免吊钩落地松绳。

Made of highly adhesive and ductile synthetic materials, it has good wear resistance, long service life, and extremely high safety even in harsh conditions. Automatically adjust the tension and tighten the steel wire rope to prevent the hook from falling and loosening the rope.



导绳器	Rope guide
排绳精准	Accurate rope arrangement
安全性能高	High security performance
减少磨损	Reduce wear and tear
安装维护便捷	Easy installation and maintenance
增强稳定性	Enhance stability
助力效果好	Good assistance effect

ADVANTAGES

产品优势

2 PLANETARY REDUCER

行星减速机

由太阳轮、行星轮、行星架、内齿圈四大基本构建组成。广泛兼容性与适应性、卓越的性能、强大的扭矩传递能力、安全可靠的设计、体积小，自重轻，扭矩大、耐冲击、免维护设计、市场认可与广泛应用、成本优势。

It consists of four basic components: sun gear, planetary gear, planetary carrier, and internal gear ring. Wide compatibility and adaptability, excellent performance, powerful torque transmission capability, safe and reliable design, small size, light weight, high torque, impact resistance, maintenance free design, market recognition and wide application, cost advantage.



行星减速机

传动效率高

传动比精确

结构紧凑

承载能力强

运转平稳、噪声低

免维护

Planetary reducer

High transmission efficiency

Accurate transmission ratio

Compact

Strong carrying capacity

Smooth operation and low noise

Maintenance-free

ADVANTAGES

产品优势

3 MOTOR

电机

锥形刹车制动，制动盘合金铝压铸加工成型后经调质处理，避免了由于刹车锅过疲劳崩碎，引起的不可估量的事故。特殊结构设计，避免了双速电机点动出现温度升高，停顿等异常情况。

Cone brake, the brake disc alloy aluminum die-casting is processed and tempered to avoid incalculable accidents caused by fatigue and breakage of the brake pan. Special structural design avoids abnormal situations such as temperature rise and pause caused by the double speed motor jogging.



电机	Motor
结构紧凑	Compact
高效节能	Efficient and energy-saving
运行稳定	Stable operation
散热良好	Good heat dissipation
控制精度高	High control accuracy
强度刚度高	High strength and stiffness

ADVANTAGES

产品优势

4 NEW TYPE OF HOOK

新型吊钩

100吨以下滑轮组采用偏心设计，减少从卷筒到吊钩滑轮组的夹角，提高钢丝绳使用寿命，吊钩组采用T级吊钩，按钩号材质为35CrMo或者34Cr2Ni2Mo；吊钩螺母和吊钩横梁采用材质35CrMo；吊钩钩壳采用高分子材料冲压而成，经久耐用。

The pulley system with a capacity of less than 100 tons adopts an eccentric design to reduce the angle from the drum to the hook pulley system, improve the service life of the steel wire rope, and the hook system adopts a T-grade hook, which is made of 35CrMo or 34Cr2Ni2Mo according to the hook number material; The hook nut and hook crossbeam are made of 35CrMo material; The hook shell is made of polymer material stamped and durable.



新型吊钩	New type of hook
安全性高	High safety
使用寿命长	long service life
防脱钩设计	Anti decoupling design
耐用材质	Durable material
维护成本低	Low maintenance cost
设计人性化	Humanized design

ADVANTAGES

产品优势

5 DRUM

卷筒

采用高强度钢材制造，经过严格的质量检测和热处理工艺，具有较高的强度、硬度和韧性，能够承受较大的起升载荷。

Made of high-strength steel and subjected to strict quality testing and heat treatment processes, it has high strength, hardness, and toughness, and can withstand large lifting loads.



卷筒	Drum
承载能力强	Strong carrying capacity
使用寿命长	long service life
制造精度高	High manufacturing precision
稳定性高	High stability
维护方便	Maintainable
高硬度高韧性	High hardness and toughness

ADVANTAGES

产品优势

6 MULTIFUNCTIONAL LIMITER

多功能限位器

旋转限位、超速开关、激光测距、纠偏、上下层防撞；内置行星减速器设置，无限寿命设计；多功能限位集行程限位、高度限位、激光测距、纠偏、上下层防撞为一体，解决了行业痛点。

Rotation limit, overspeed switch, laser ranging, correction, upper and lower collision avoidance; Built in planetary gearbox setting, with an infinite lifespan design; The multifunctional limit integrates travel limit, height limit, laser ranging, correction, and upper and lower collision avoidance, solving industry pain points.



多功能限位器	Multifunctional limiter
精确限位控制	Precise limit control
安全性能卓越	Excellent safety performance
设计安装便捷	Easy to design and install
维护保养轻松	Easy maintenance and upkeep
材质坚固耐用	Durable and sturdy material
用户体验良好	Good user experience

ADVANTAGES
产品优势

7 INTEGRATED ELECTRICAL
集成电气

集成多种保护电路，制动控制等功能，具有完美性能及低价成本；标准化程度高，体积紧凑，安装方便，里面控制线路已固化，用户只要简单接入电源进线以及电机线，信号线就能正常运行。

Integrate multiple protection circuits, brake control and other functions, with perfect performance and low cost; Highly standardized, compact in size, easy to install, and the control circuit inside has been solidified. Users only need to simply connect the power input line and motor line, and the signal line can operate normally.



集成电气	Integrated Electrical
高度集成化	Highly integrated
高可靠性	High reliability
降低能耗	Reduce energy consumption
智能化控制	Intelligent control
易于扩展和升级	Easy to expand and upgrade
故障诊断与预警	Fault diagnosis and warning

ADVANTAGES

产品优势

8 COUPLING

联轴器

规格：起升用弹性梅花轮联轴器、运行用联轴器运行用弹性梅花轮联轴器。性能：材质采用20CrMnTi,碳氮共渗,表面硬度HRC58-61，有效硬化层深0.5-0.8，中部采用高强度聚氨酯联结。

Specifications: Elastic plum blossom brake wheel coupling for lifting, elastic plum blossom wheel coupling for lifting, and elastic plum blossom wheel coupling for operation. Performance: The material is made of 20CrMnTi, carbonitrided, with a surface hardness of HRC58-61, an effective hardening layer depth of 0.5-0.8, and high-strength polyurethane bonding in the middle.



联轴器

Coupling

弹性缓冲

Elastic buffer

较强的位移补偿能力

Strong displacement compensation

安装维护便捷

Easy installation and maintenance

耐磨损与长寿命

Wear resistance and long lifespan

适应性强

Strong adaptability

轻量化设计

lightweight design

ADVANTAGES 产品优势



◆ Structure Design 结构设计

一体化紧凑布局，行星减速机与葫芦内置集成，体积小、重量轻；底座采用高强度焊接结构，承重稳定，配合模块化设计，拆装维护便捷；内置多重安全保护（过载、限位、防坠），结构冗余度高。

◆ Performance Performance 性能表现

行星传动效率达 95% 以上，能耗低；齿轮精度高，运行噪音 $\leq 75\text{dB}$ ，启停平稳；传动比精准，起升速度可调（单/双速可选），定位误差小；减速机承载能力强，抗冲击性优，工作级别可达 A5，使用寿命长。

◆ Application adaptation 应用适配

兼容工业生产线、仓储物流、建筑施工等固定工位起重需求；支持防爆、防腐等特殊工况定制，适配重载高频或精准吊装场景，通用性强。

SZW

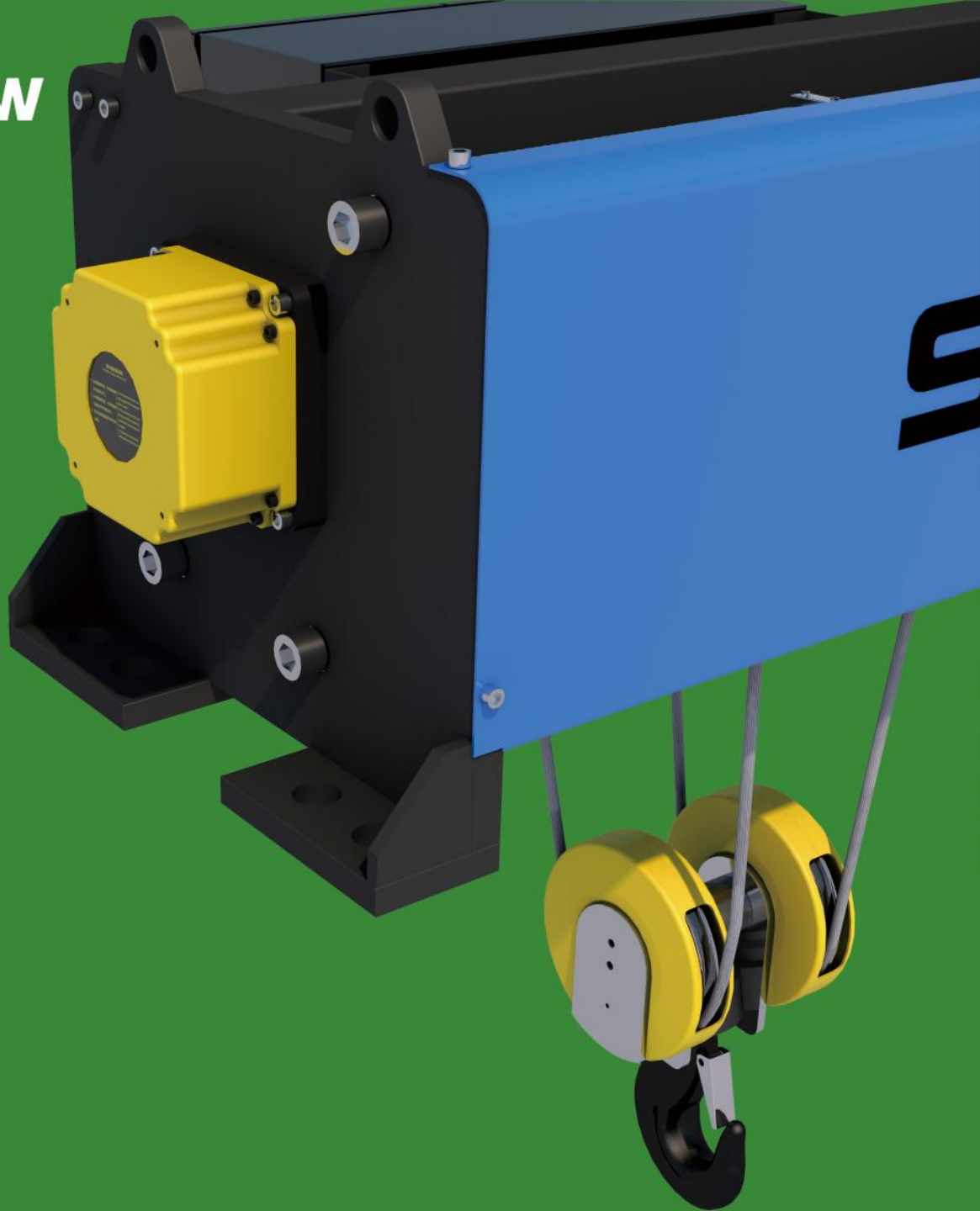

WIN THE FUTURE WITH INNOVATION
用新赢未来



案例
CASE

CASE 案例



河南三智装备座式葫芦，以工业级品质赋能多场景起重作业，成为制造、建筑、物流等领域的可靠伙伴。从精准吊装到高效转运，每一处细节都彰显着专为严苛工况打造的硬核实力，用稳定表现诠释专业起重设备的价值。

Henan Sanzhi Equipment's overhead hoist empowers multi-scenario lifting operations with industrial-grade quality, serving as a reliable partner in manufacturing, construction, logistics, and other fields. From precise hoisting to efficient transportation, every detail demonstrates its hardcore strength designed for demanding working conditions, embodying the value of professional lifting equipment through stable performance.

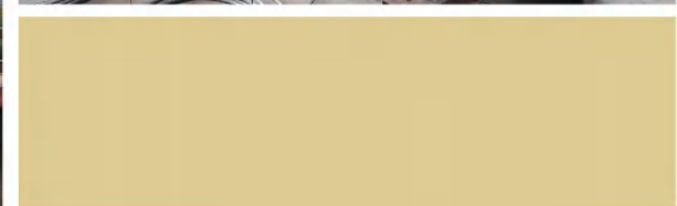

SZW



WIN THE FUTURE WITH INNOVATION
用新赢未来



服务

SERVICE

SERVICE

服务

◆ BEFORE SERVICE

售前服务

免费为用户提供技术咨询服务；向用户提供产品样本，企业简介，资信证明等资料；诚邀至我司考察产品设计、工艺流程和质量管理体系；委派技术人员根据现场情况和用户需求进行设计、选型。

◆ IN SALES SERVICE

售中服务

产品制造过程中，用户相关人员可到我公司监察制造过程中各个工序；向用户相关人员提供产品全流程制造检验标准和制造检验结果。

◆ AFTER-SALE SERVICE

售后服务

结合用户需求进行培训，及时改进产品；坚决执行产品“三包”服务政策；对客户来电来函信息8小时内处理完毕答复，服务工程师24小时待命制，离开现场需客户许可；批量订单业务，提供为期三个月保姆式跟踪服务。





河南·长垣

河南三智装备科技有限公司
Henan Sanzhi Equipment Technology Co., Ltd

公司网址 <http://www.szwzb.com>
服务热线 0373-8698966
公司地址 河南省长垣市起重工业园区纬二路1号

Website <http://www.szwzb.com>
Tel 0373-8698966
Address No.1 Weier Road Industrial Park Changyuan City Henan Province